

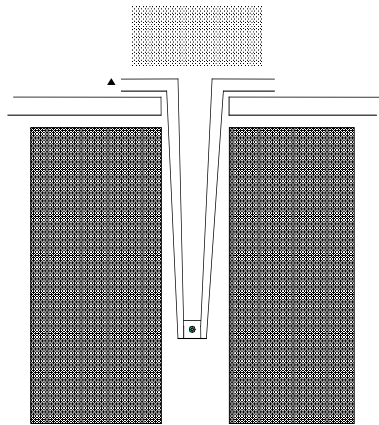

Progress on Z-Pinch Inertial Fusion Energy

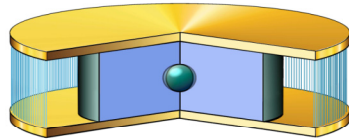

RTL



DH target

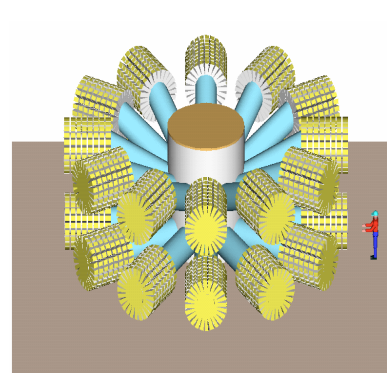

LTD driver

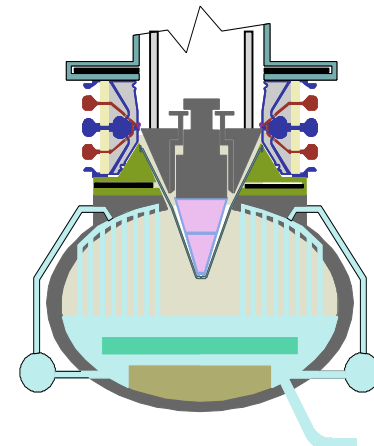

Chamber

Craig L. Olson
Sandia National Laboratories
Albuquerque, NM 87185
USA

20th IAEA Fusion Energy Conference
Vilamoura, Portugal
1-6 November 2004



Sandia is a multiprogram laboratory operated by Sandia Corporation, a Lockheed Martin Company, for the United States Department of Energy's National Nuclear Security Administration under contract DE-AC04-94AL85000.



The Z-Pinch IFE Team

C. Olson 1), G. Rochau 1), M. K. Matzen 1), S. Slutz 1), C. Morrow 1), R. Olson 1), M. Cuneo 1), D. Hanson 1), G. Bennett 1), T. Sanford 1), J. Bailey 1), W. Stygar 1), R. Vesey 1), T. Mehlhorn 1), K. Struve 1), M. Mazarakis 1), M. Savage 1), T. Pointon 1), M. Kiefer 1), S. Rosenthal 1), K. Cochran 1), L. Schneider 1), S. Glover 1), K. Reed 1), D. Schroen 1), C. Farnum 1), M. Modesto 1), D. Oscar 1), L. Chhabildas 1), J. Boyes 1), V. Vigil 1), R. Keith 1), M. Turgeon 1), B. Cipiti 1), E. Lindgren 1), V. Dandini 1), H. Tran 1), D. Smith 1), D. McDaniel 1), J. Quintenz 1), J. P. VanDevender 1), W. Gauster 1), L. Shephard 1), M. Walck 1), T. Renk 1), T. Tanaka 1), M. Ulrickson 1), W. Meier 2), J. Latkowski 2), R. Moir 2), R. Schmitt 2), S. Reyes 2), R. Abbott 2), R. Peterson 3), G. Pollock 3), P. Ottinger 4), J. Schumer 4), P. Peterson 5), D. Kammer 6), G. Kulcinski 6), L. El-Guebaly 6), G. Moses 6), I. Sviatoslavsky 6), M. Sawan 6), M. Anderson 6), R. Bonazza 6), J. Oakley 6), P. Meekunasombat 6), J. De Groot 7), N. Jensen 7), M. Abdou 8), A. Ying 8), P. Calderoni 8), N. Morley 8), S. Abdel-Khalik 9), C. Dillon 9), C. Lascar 9), D. Sadowski 9), R. Curry 10), K. McDonald 10), M. Barkey 11), W. Szaroletta 12), R. Gallix 13), N. Alexander 13), W. Rickman 13), C. Charman 13), H. Shatoff 13), D. Welch 14), D. Rose 14), P. Panchuk 15), D. Louie 16), S. Dean 17), A. Kim 18), S. Nedoseev 19), E. Grabovsky 19), A. Kingsep 19), V. Smirnov 19)

1) Sandia National Laboratories, Albuquerque, NM, USA

2) Lawrence Livermore National Laboratory, Livermore, CA, USA

3) Los Alamos National Laboratories, Los Alamos, NM, USA

4) Naval Research Laboratory, Washington, DC, USA

5) University of California, Berkeley, CA, USA

6) University of Wisconsin, Madison, WI, USA

7) University of California, Davis, Davis, CA, USA

8) University of California, Los Angeles, Los Angeles, CA, USA

9) Georgia Institute of Technology, Atlanta, Georgia, USA

10) University of Missouri-Columbia, Columbia, MO, USA

11) University of Alabama, Tuscaloosa, AL, USA

12) University of New Mexico, Albuquerque, NM, USA

13) General Atomics, San Diego, CA, USA

14) Mission Research Corporation, Albuquerque, NM, USA

15) EG&G, Albuquerque, NM, USA

16) Omicron, Albuquerque, NM, USA

17) Fusion Power Associates, Gaithersburg, MD, USA

18) Institute of High Current Electronics, Tomsk, Russia

19) Kurchatov Institute, Moscow, Russia



The *long-term* goal of Z-Pinch IFE is to produce an economically attractive power plant using high-yield z-pinch-driven targets (~ 3 GJ) at low rep-rate per chamber (~ 0.1 Hz)

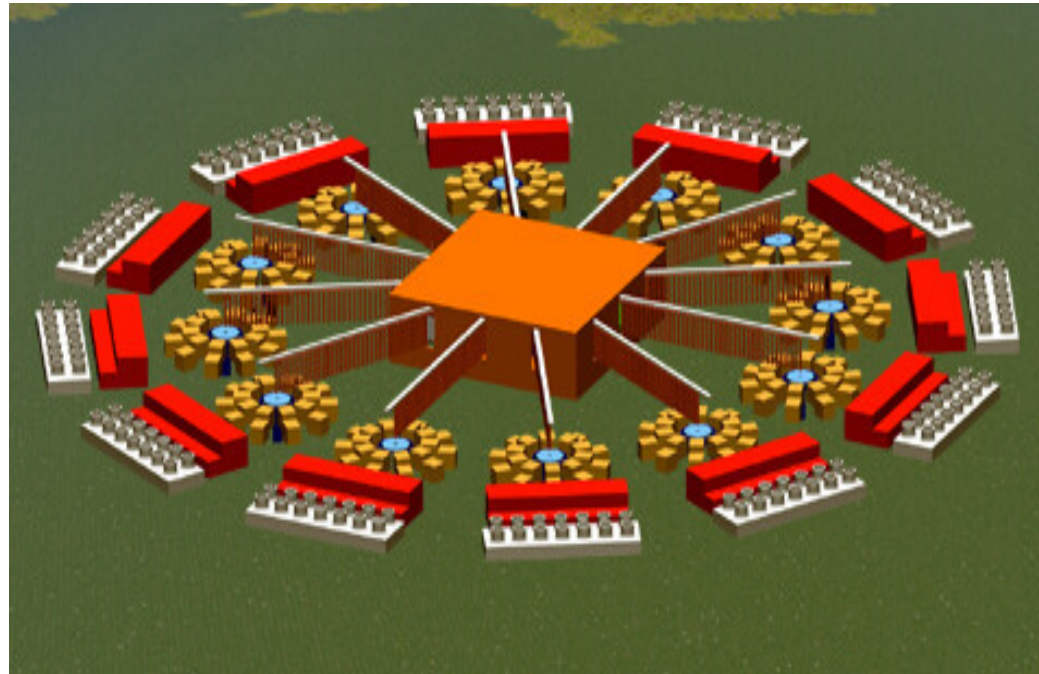

Z-Pinch IFE DEMO (ZP-3, the first study) used 12 chambers, each with 3 GJ at 0.1 Hz, to produce 1000 MWe

The *near-term* goal of Z-Pinch IFE is to address the science issues of repetitive pulsed power drivers, recyclable transmission lines, high-yield targets, and thick-liquid wall chamber power plants

Z-Pinch is the newest of the three major drivers for IFE

*1999 Snowmass Fusion Summer Study, IAEA CRP on IFE Power Plants,
2002 Snowmass Fusion Summer Study, FESAC 35 -year plan Panel Report (2003),
FESAC IFE Pane 1 Report (2003)*

Major drivers:

Laser
(KrF, DPSSL)

Heavy ion
(induction linac)
GeV, kA

Z-pinch
(pulsed power)
MV, MA

Targets:

Direct-drive

Indirect-drive

Fast Igniter option
(major driver + PW laser)

Chambers:

Dry-wall

Wetted-wall

Thick-liquid wall

Solid/voids

**Thick liquid walls essentially alleviate the “first wall” problem,
and can lead to a faster development path**



What has already been accomplished that is relevant to Z-Pinch IFE

x-rays: 1.8 MJ of x-rays, up to 230 TW, on Z (**demonstrated**) available now

low cost: ~\$30/J for ZR (**demonstrated** cost)

high efficiency: wall plug to x-rays: ~15% on Z (**demonstrated**)
can be optimized to: ~25% or more

capsule compression experiments on Z:

double-pinch hohlraum¹ (~70 eV): Cr ≈ 14-20 (**demonstrated**)
symmetry ~3% (**demonstrated**)

dynamic hohlraum² (~220 eV): ~ 24 kJ x-rays absorbed, Cr ≈ 10,
up to 8×10^{10} DD neutrons (**demonstrated**)

hemisphere compression for fast ignition³: Cr ≈ 3 (**demonstrated**)

(¹Cuneo, et al.; ²Bailey, Chandler, Vesey, et al.; ³Slutz, et al.)

repetitive pulsed power:

RHEPP magnetic switching technology:

2.5 kJ @ 120 Hz (300 kW ave. pwr. **demonstrated**)

LTD (linear transformer driver) technology:

being developed (compact, direct, simple)



The Recyclable Transmission Line (RTL) Concept

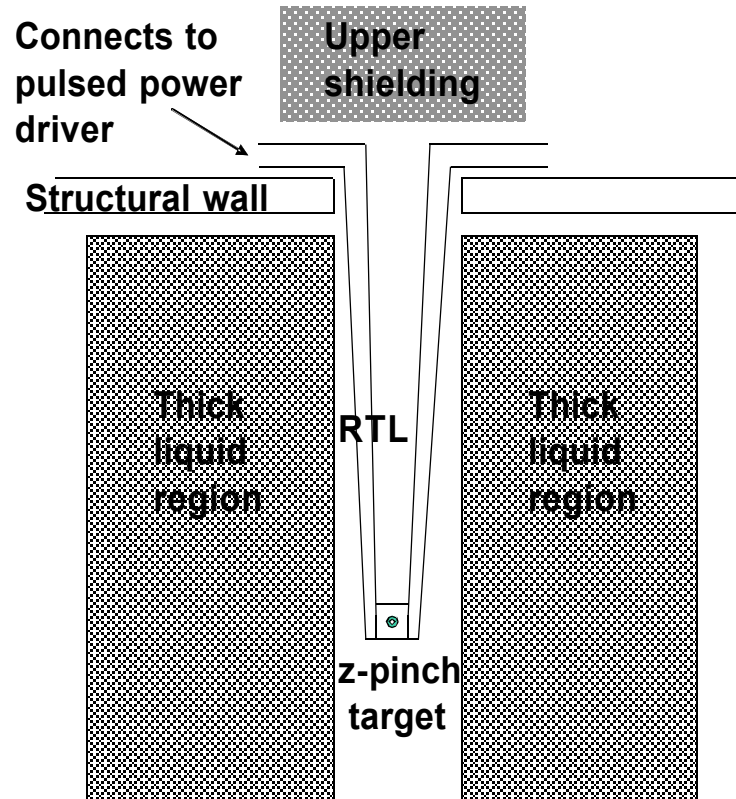

- Eliminates problems of final optic, pointing and tracking N beams, and high-speed target injection
- Requires development of RTL



Z-Pinch IFE Power Plant has a Matrix of Possibilities

Z-Pinch Driver:

Marx generator/
water line technology

magnetic switching
(RHEPP technology)

linear transformer driver
(LTD technology)

RTL (Recyclable Transmission Line):

frozen coolant
(e.g., Flibe/ electrical coating)

immiscible material
(e. g., low activation ferritic steel)

Target:

double-pinch

dynamic hohlraum

fast ignition

Chamber:

dry-wall

wetted-wall

thick-liquid wall

solid/voids
(e. g., Flibe foam)

red line shows preferred approach



Research is addressing the following primary issues for z-pinch IFE for FY04

1. How feasible is the RTL concept?
2. What repetitive pulsed power drive technology could be used for z-pinch IFE?
3. Can the shock from the high-yield target (~3 GJ) be effectively mitigated to protect the chamber structural wall?
4. Can the full RTL cycle (fire RTL/z-pinch, remove RTL remnant, insert new RTL/z-pinch) be demonstrated on a small scale?
Z-PoP (Proof-of-Principle) is 1 MA, 1 MV, 100 ns, 0.1 Hz
5. What is the optimum high-yield target for 3 GJ?
6. What is the optimum power plant scenario for z-pinch IFE?

- Z-Pinch IFE Workshop held at SNL on August 10-11, 2004:
64 Participants - Outstanding initial results in all areas
- TOFE in Madison, WI on September 14-16, 2004:
14 talks/posters on Z-pinch IFE

Selected initial results for each of the 6 research areas follow:



1. RTLs

Recyclable Transmission Line (RTL) status/issues

RTL movement	small acceleration – not an issue
RTL electrical turn-on	RTL experiments at 10 MA on Saturn
RTL low-mass limit	RTL experiments at 10 MA on Saturn
RTL electrical conductivity	RTL experiments at 10 MA on Saturn
RTL structural properties	ANSYS simulations, buckling tests
RTL mass handling	comparison with coal plant
RTL shrapnel formation	under study
RTL vacuum connections	commercial sliding seal system
RTL electrical connections	under study
RTL activation	1-1.5 day cool down time
RTL shock disruption to fluid walls	experiments/simulations in progress
RTL manufacturing/ cost	~\$3 budget, current estimate ~\$3.95
RTL inductance, configuration	circuit code modeling in progress
RTL power flow limits	ALEGRA, LSP simulations
Effects of post-shot EMP, plasma, droplets, debris up the RTL	– under study
Shielding of sensitive accelerator/power flow feed parts	– under study
...	



MITL/RTL Issues for 20 MA \Rightarrow 60 MA \Rightarrow 90 MA
(now on Z) (high yield) (IFE)

- Surface heating, melting, ablation, plasma formation
- Electron flow, magnetic insulation
- Conductivity changes
- Magnetic field diffusion changes
- Low mass RTL material moves more easily
- Possible ion flow

these issues become most critical right near the target

I	20 MA	60 MA	90 MA
R_{array} (z-pinch)	? 2 cm	? 2 cm	? 5 cm
$I / (2? R_{array})$? 1.6 MA/cm	? 4.8 MA/cm	? 2.9 MA/cm
MITL	Works on Z	?	?
RTL	?	?	?

Initial ALEGRA and LSP simulations suggest all should work at these linear current densities, which are \ll 20 MA/cm



1. RTLs

RTL Structural Testing is Starting

- **Model Validation**
 - Testing Diagram

- **RTLs manufactured for tests**
 - 2 meter RTLs



THE UNIVERSITY OF
ALABAMA
FOUNDED 1831

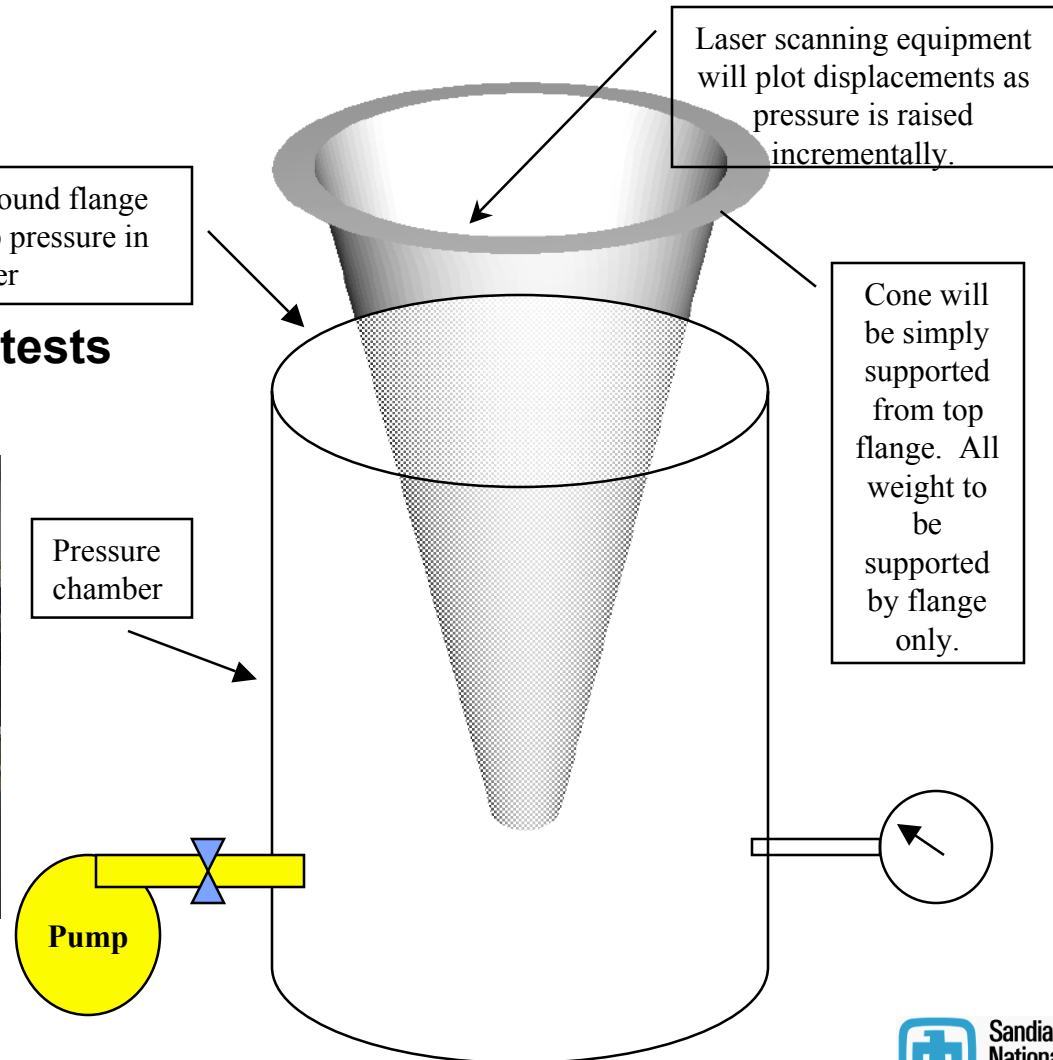



Linear Transformer Driver (LTD) technology is compact and easily rep-rateable

2. Repetitive driver

- LTD uses parallel-charged capacitors in a cylindrical geometry, with close multiple triggered switches, to directly drive inductive gaps for an inductive voltage adder driver (Hermes III is a 20 MV inductive voltage adder accelerator at SNL)
- LTD requires **no oil tanks or water tanks**
- LTD study (as shown) would produce 10 MA in **about 1/4 the volume** of Saturn
- LTD pioneered at Institute of High Current Electronics in Tomsk, Russia

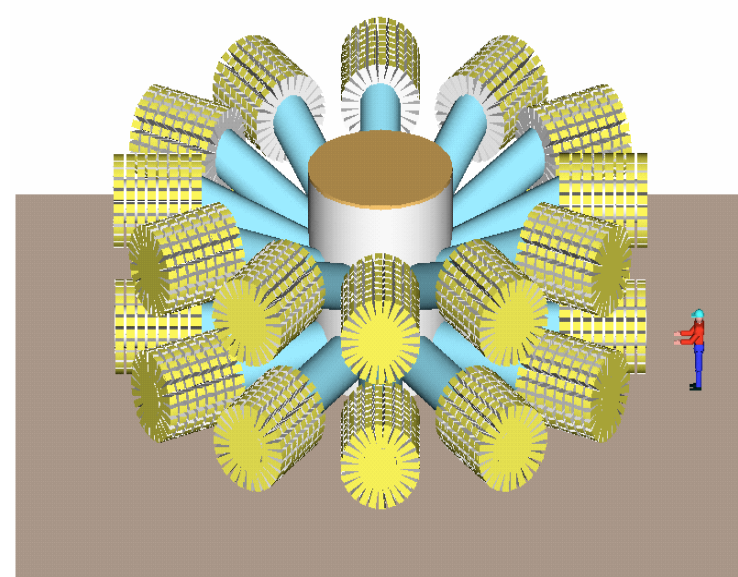

Modular

High Efficiency (~ 90% for driver)

Low Cost (estimates are ~1/2 that for Marx/water line technology)

Easily made repetitive for 0.1 Hz



One 1-MA LTD cavity built - performs as expected during first 100 shots (two more cavities ordered – need ten for Z-PoP)

2. Repetitive driver

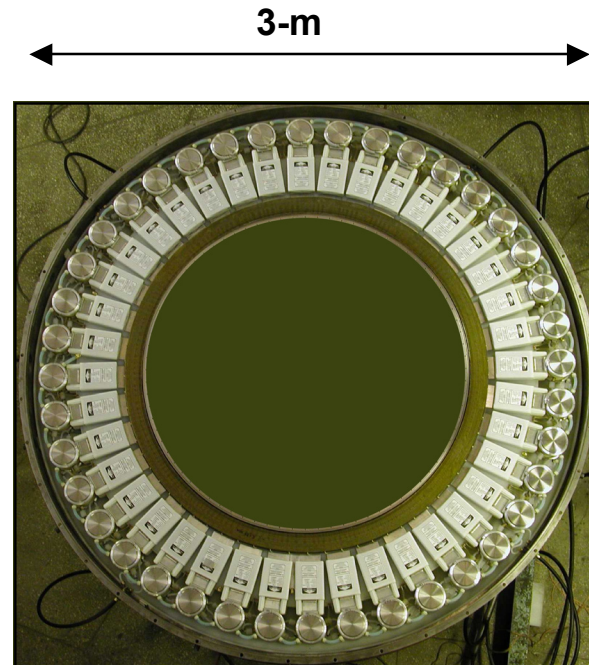
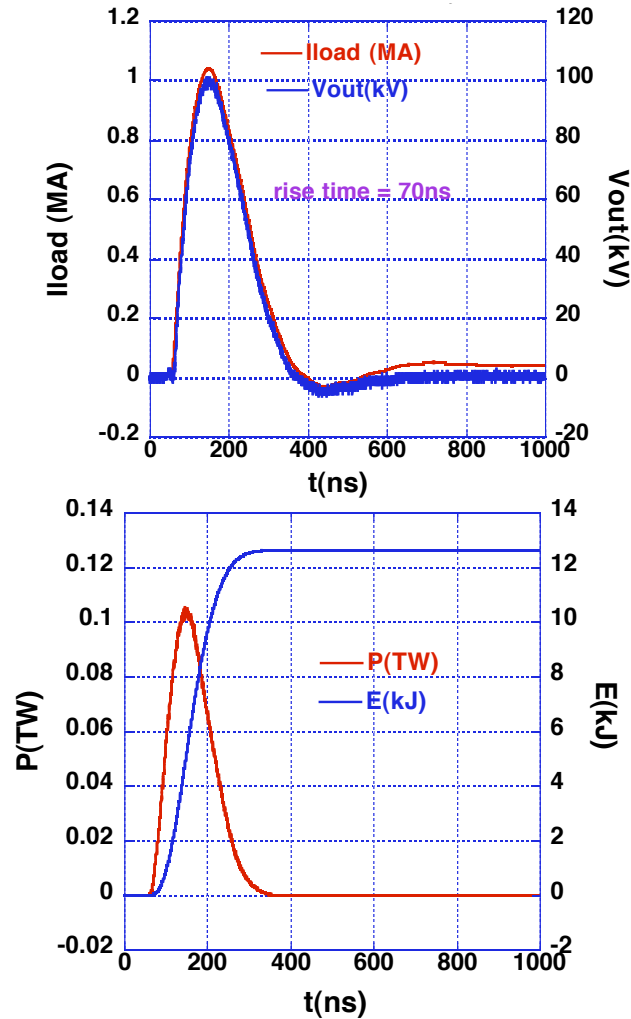

1-MA, 100kV, 70ns LTD cavity (top flange removed)

80 Maxwell 31165 caps,

40 switches, ± 100 kV

0.1 Ohm load **0.1TW**

3. Shock mitigation

Shock mitigation experiments/code calculations in progress

Shock tube + water layers

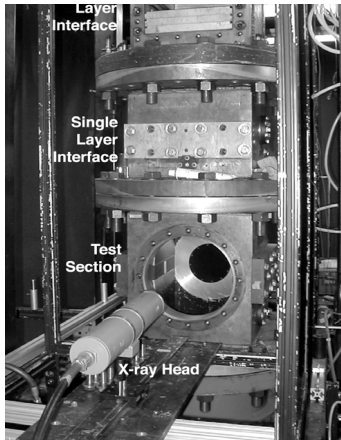

Shock tube facility at the University of Wisconsin

Explosives with water curtain

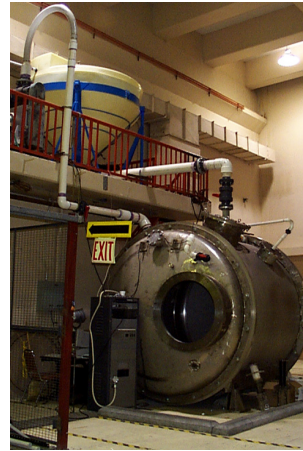

Vacuum Hydraulics Experiment (VHEX) at UCB

Foamed liquid sheets

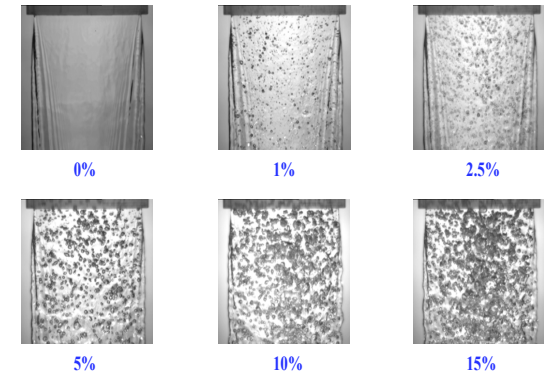

Georgia-Tech

ALEGRA simulation of shocked metal foam sheet (SNL)

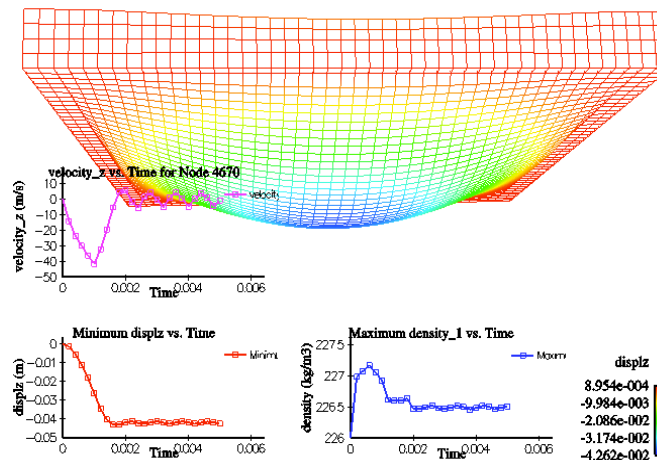



4. PoP planning

Robotic automation is very close to that needed for Z-Pinch IFE

- Commercial off-the-shelf (COTS) robotics:
 - Improvements in typical specs:
 - Payloads up to 60 kg
 - Placement accuracy to 0.04 mm
 - Workspace: ~1.5_1.5_1 m
 - Velocity: 1.5m in < 2 s
 - Multiple vendor options





Dynamic hohlraum and double-ended hohlraum targets scale to Z-IFE with gains ~ 100

5. Z-IFE targets

Double-Ended Hohlraum

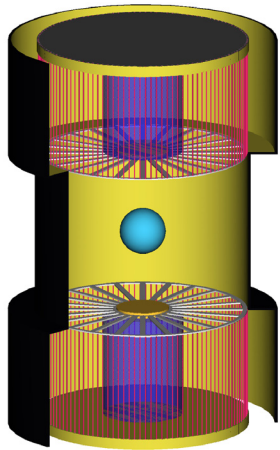

Dynamic Hohlraum

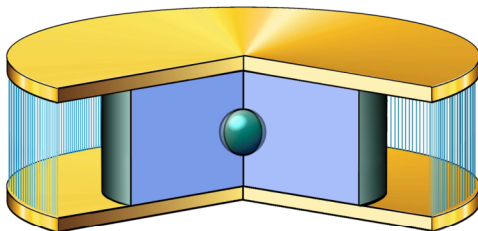

	ICF	IFE
Peak current	2 x (62 – 82) MA	
Energy delivered to pinches	2 x (19 – 33) MJ	
Z-pinch x-ray energy output	2 x (9 – 16) MJ	
Capsule absorbed energy	1.2 – 7.6 MJ	
Capsule yield	400 – 4700 MJ	
Peak current	56 – 95 MA	
Energy delivered to pinch	14 – 42 MJ	
Capsule absorbed energy	2.4 – 7.2 MJ	
Capsule yield	530 – 4600 MJ	





The first Z-Pinch Power Plant study (ZP3) provides a complete, but non-optimized, concept for an IFE Power Plant

6. Power Plant

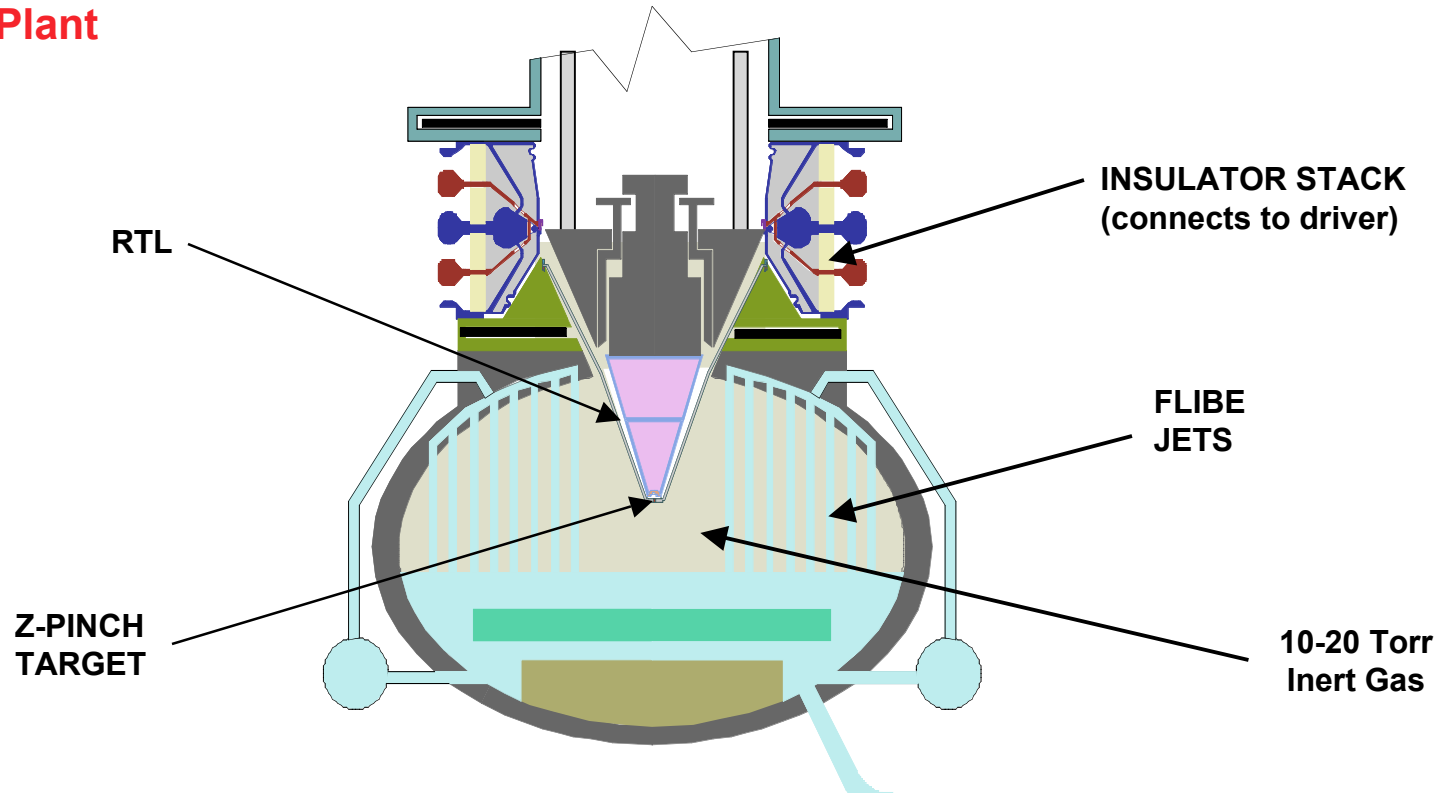

Yield and Rep-Rate: few GJ every 3-10 seconds per chamber (0.1 Hz - 0.3 Hz)

Thick liquid wall chamber: only one opening (at top) for driver; nominal pressure (10-20 Torr)

RTL entrance hole is only 1% of the chamber surface area (for $R = 5$ m, $r = 1$ m)

Flibe absorbs neutron energy, breeds tritium, shields structural wall from neutrons

Neutronics studies indicate 30 year wall lifetimes

Activation studies indicate 1-1.5 days cool-down time for RTLs

Studies of waste steam analysis, RTL manufacturing, heat cycle, etc. in progress

Z-Pinch IFE Road Map

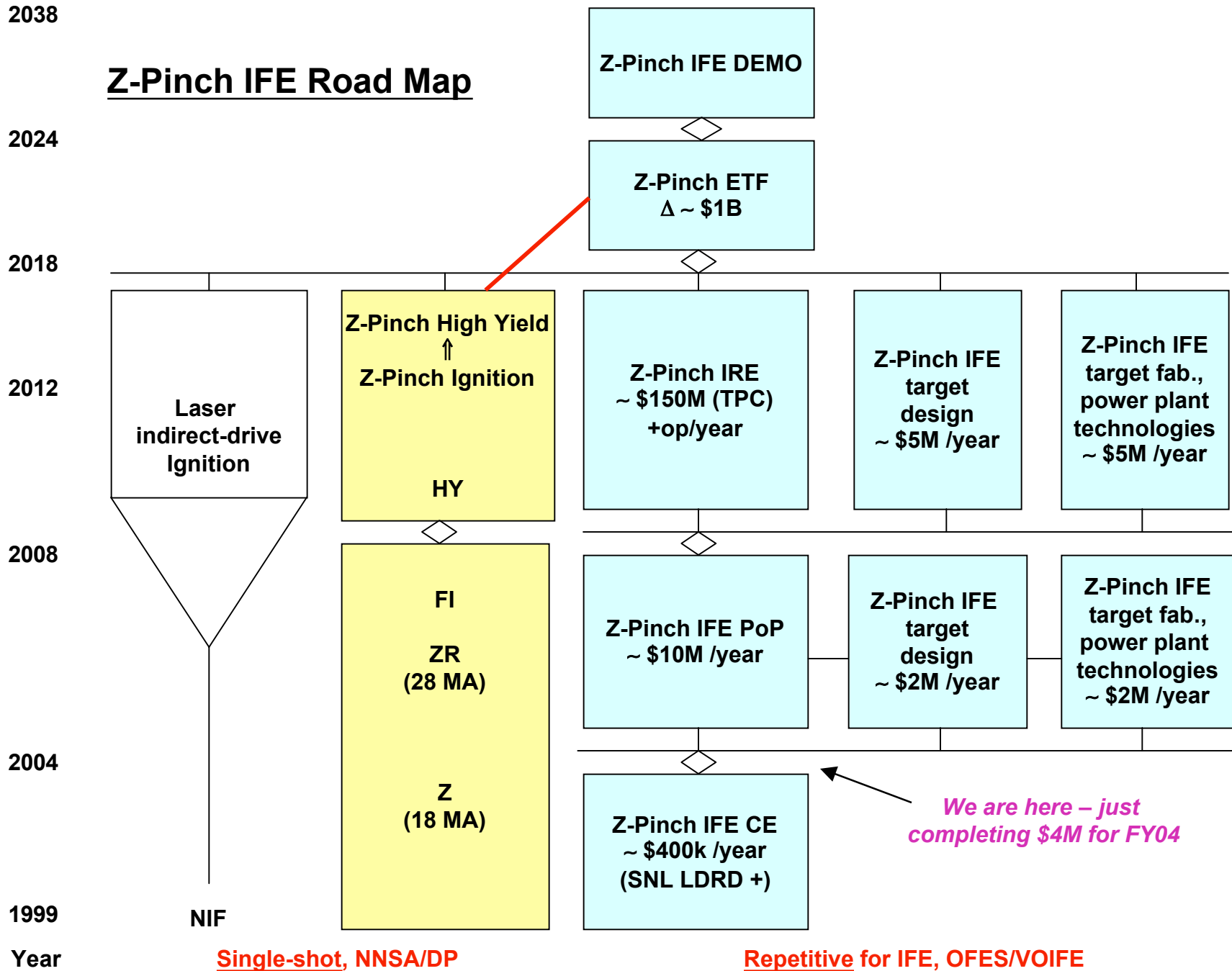

Z-Pinch IFE Development Path *Facilities*

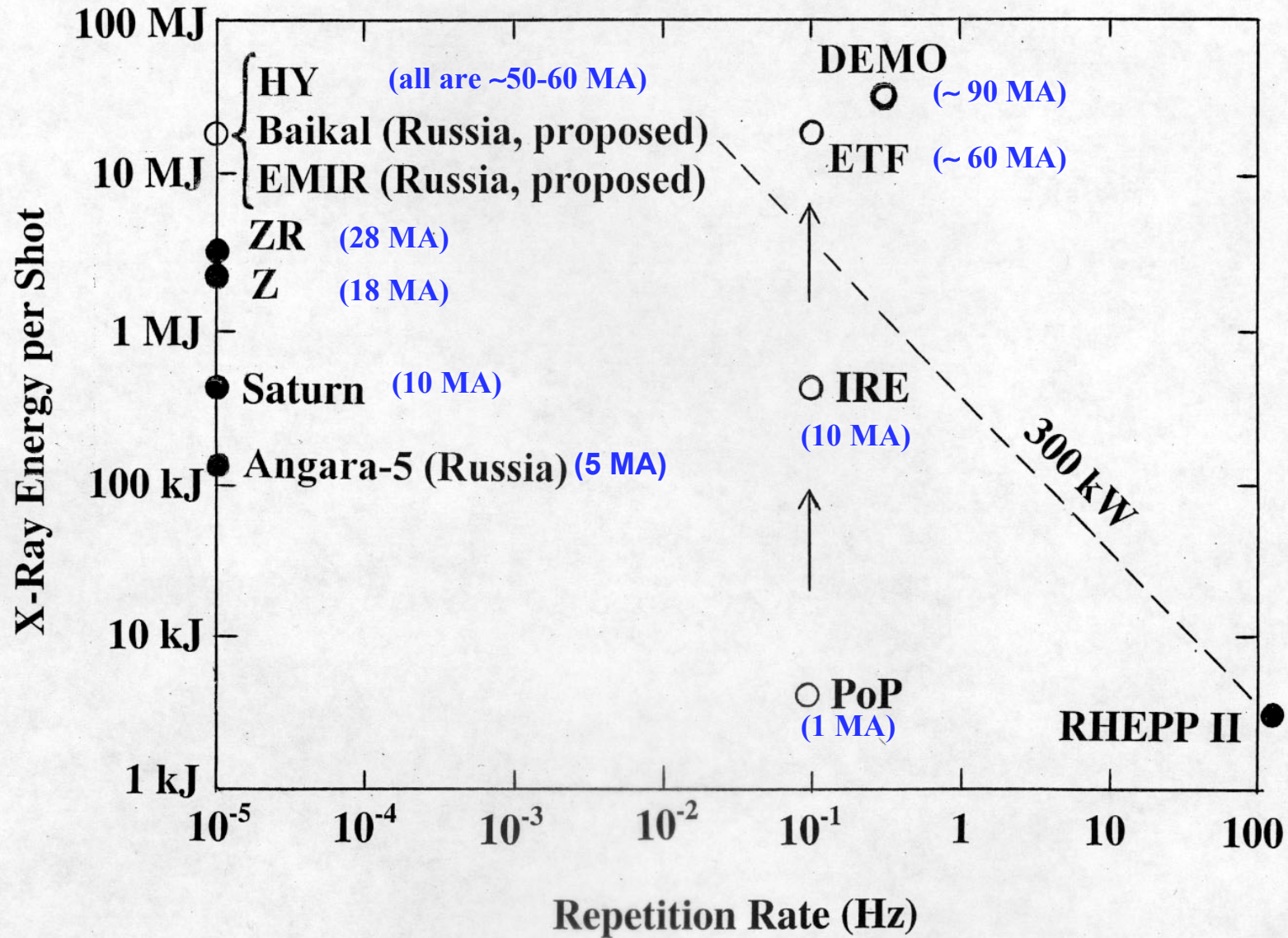

Wire Array Z-Pinch Precursors, Implosions and Stagnation

M.G. Haines, S.V. Lebedev, J.P. Chitenden, S.N. Bland, M. Sherlock, D.J. Ampleford, S.C. Bott, G.N. Hall, C. Jennings, J. Rapley, *Imperial College, London*
P.D. Le Pell, C.A. Coverdale, B. Jones, C. Deeney, *Sandia National Laboratories, Albuquerque, NM*

PURPOSE: Understand wire array plasma precursors, implosions, and stagnation at 1.5 MA on MAGPIE, considering the radiated z-pinch energy can sometimes be 3-4 times the kinetic energy

(1) Precursor plasma velocities and densities

High global B increases the ablation rate

gap size/core size: small ratio \Rightarrow ablation velocity constant

large ratio \Rightarrow ablation velocity decreases

ablation velocities affect radial density profile just prior to main implosion

precursor plasmas modeled with hybrid code model

3-D MHD simulations for MAGPIE

(2) Effects that can increase the final x-ray radiation

Late implosion of trailing mass

$m=1$ instabilities \Rightarrow increased Ohmic dissipation

$m=0$ instabilities \Rightarrow ion viscous heating (on Z at 20 MA, may explain ion temperatures of 100-300 keV)

Investigations of Radiating Z Pinches for ICF

E.V. Grabovski, V.V. Alexandrov, G.S. Volkov, M.V. Zurin, V.I. Zaitzev, K.N. Mitrofanov, S.L. Nedoseev, G.M. Oleinik, I.Yu. Porofeev, A.A. Samokhin, M.V. Fedulov, I.N. Frolov, E.A. Azizov, V.P. Bakhtin, A.N. Gribov, Yu.A. Khalimulin, V.F. Levashov, A.P. Lototsky, A.M. Zhitlukhin, M.K. Krylov, V.D. Pismenny, E.P. Velikhov, G.I. Dolgachev, Yu.G. Kalinin, A.S. Kingsep, V.P. Smirnov, [SCR RF TRINITI](#)
V.A. Glukhikh, V.G. Kuchinsky, O.P. Pechersky, [RRC Kurchatov Insititute](#)
I.A. Glazyrin, A.I. Kormilitsin, G.N. Rykovanov, [Efremov Institute](#)

PURPOSE: Investigations leading to creation of facility BAIKAL for thermonuclear target ignition (and yield)

1. Wire array implosion investigations on ANGARA-5-1 (5 MA, 100 ns)

X-pinch: x-ray radiography of wire array during implosion

measure density distribution and look at precursor plasmas

magnetic micro-probes: measure B at various radii

(inside inner array, between arrays, outside outer array)

1-D and 2-D simulations of wire arrays

2. For BAIKAL project, develop one prototype module (MOL): 4.5 MV, 1.5 MJ, 150 ns

inductive store (12 MJ)

magnetic amplifier

magnetic compressor (100 μ s – 2 μ s)

transformer

POS (sharpens to 150 ns)

imitator load

ANGARA-5-1

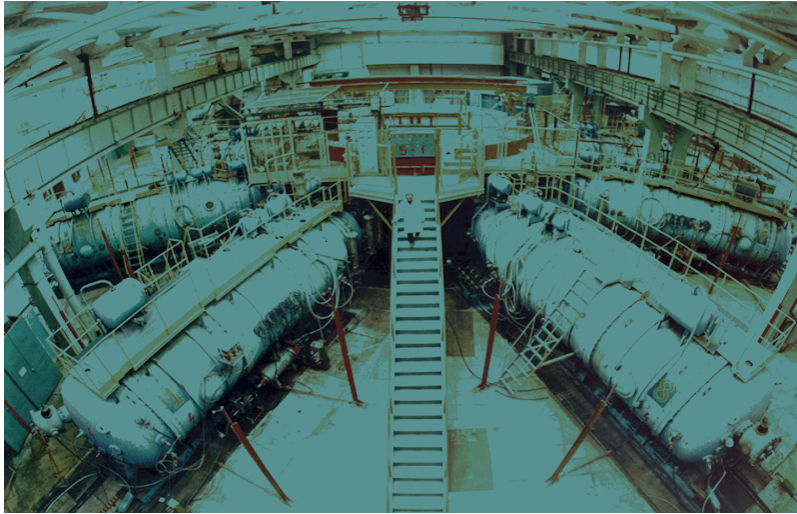

BAIKAL Project

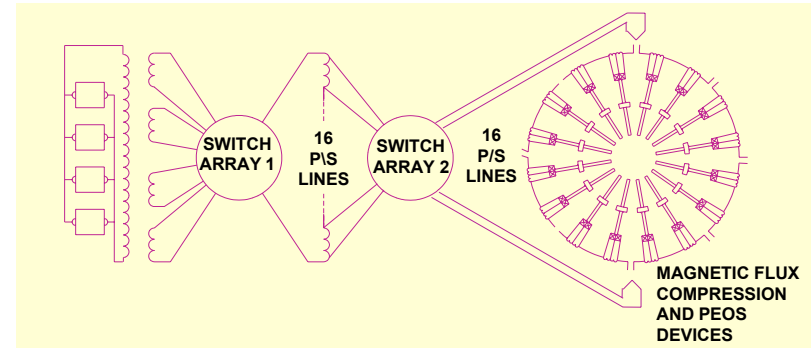

MOL inductive storage

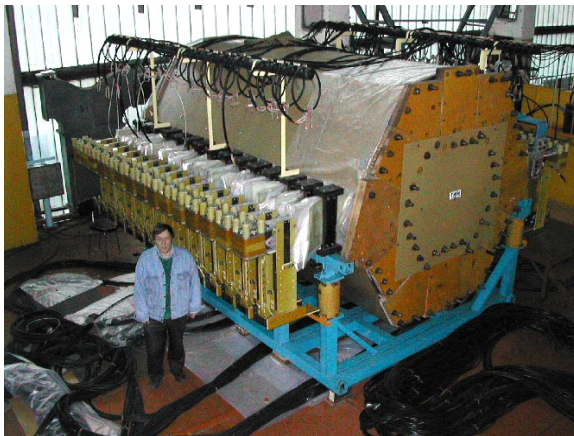

TIN 900 view in TRINITI

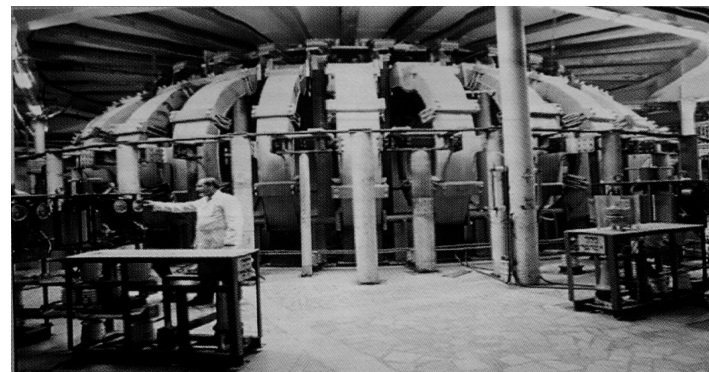

Investigations of Radiating Z Pinches for ICF

Yu. Kalinin, Yu. Bakshaev, A. Bartov, P. Blinov, A. Chernenko, K. Chukbar, S. Danko, G. Dolgachev, A. Fedotkin, A. Kingsep, D. Maslennikov, V. Mizhiritsky, A. Shashfov, V. Smirnov, [Kurchatov Institute](#)
I. Kovalenko, A. Lobanov, [Moscow Institute for Physics and Technology](#)

PURPOSE: Investigation of z-pinch wire array implosions on S-300

(1) Experiments on S-300 (3 MA, 100 ns, 0.15 ohm) at Kurchatov

Pass through of outer array through inner array

Plasma flow switch

S-300



(2) POS study on RS-20 facility (1 MV, 350 kA, 2 μ s) for BAIKAL project

remove 40 μ s prepulse leaving 100 ns main pulse

extra slides



RTL replacement requires only modest acceleration for IFE

$$L = 0.5 a t^2, \text{ or } a \sim 1/t^2$$

Acceleration is 10^4 less than for IFE target injection for ions or lasers

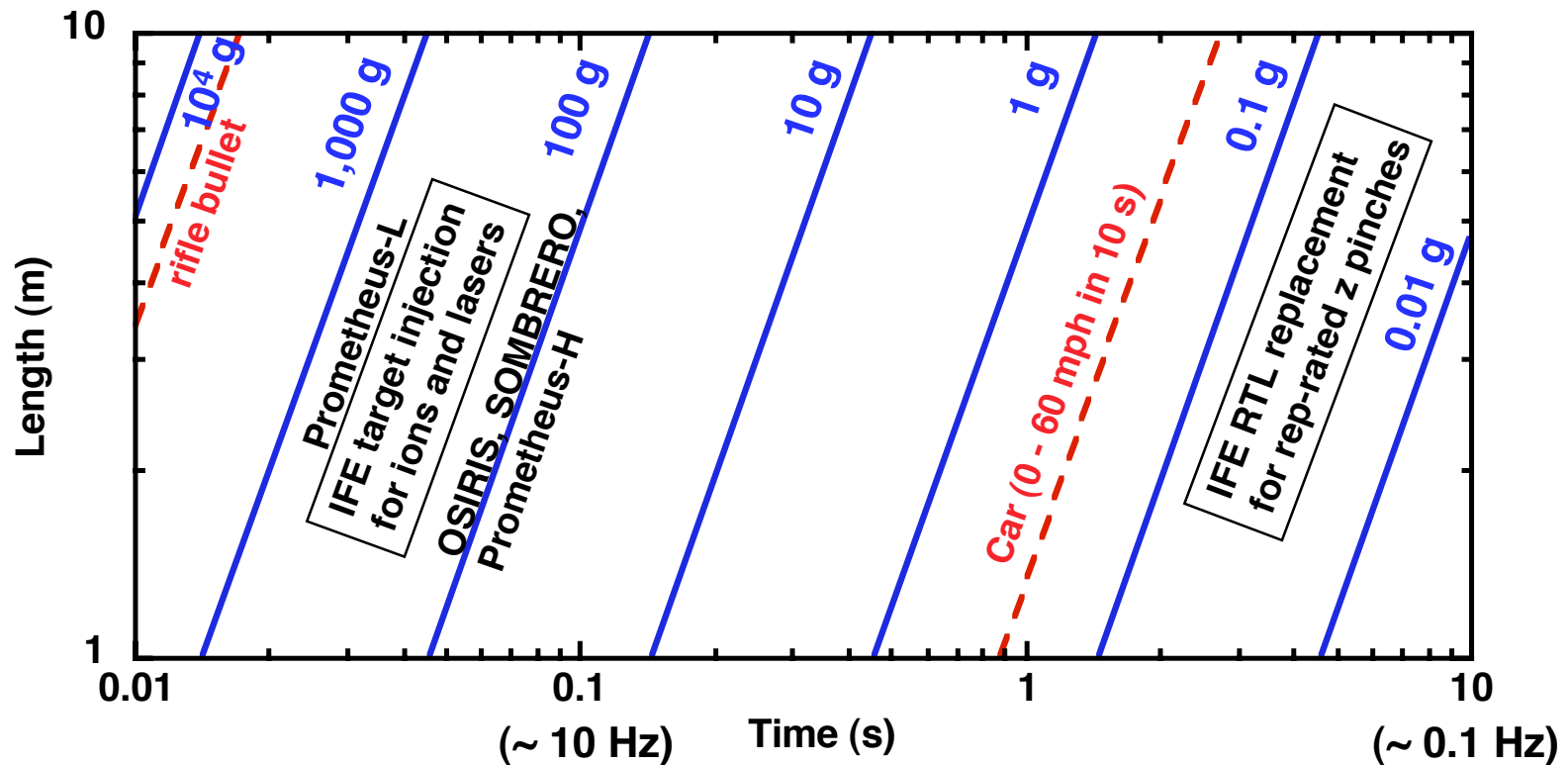



RTL mass handling

One day storage supply of RTLs (at 50 kg each) has a mass comparable to one day's waste from a coal plant

**Z-Pinch IFE
(1 GWe Power Plant)**

**RTLs one-day storage
supply at site is 5,000 tons**

**RTLs are recycled with
minimum waste**

**Coal-fired Power Plant
San Juan Generating Station (1.6 GWe)
(Four Corners area, NM)**

**Burns: 7 million tons coal/year
Waste: 1.5 million tons/year**

**Coal 30-day storage supply
at site is 600,000 tons**

**Burns: 20,000 tons/day
Waste: 5,000 tons/day
(flyash and gypsum, that must be
disposed of in the adjacent coal mine)**



RTL research completed prior to 2004 (under LDRD) had encouraging results

- RTL electrical turn-on** Saturn experiments at 10 MA (2000)
tin, Al, stainless-steel all show negligible losses
- RTL low-mass and electrical conductivity** Saturn experiments at 10 MA (2001)
20 μ mylar; 50 μ , 100 μ , 250 μ steel
RTL mass could be as low as 2 kg
RTL mass ~ 50 kg has low resistive losses
- RTL structural** Calculations (U. Wisconsin) (2002)
full-scale RTL (~50 kg) of 25 mill steel ok for
background pressure ~ 10-20 Torr
- RTL manufacturing** (allowed RTL budget is a few \$ for 3 GJ)
Flibe casting (~\$0.70/RTL)
ferritic steel stamping (~ \$1.20-3.95/RTL)